

# SINGLE FREQUENCY LASER DIODES

## Distributed Feedback Laser



### General Product Information

Product	Application
Tunable 760 nm DFB Laser	Spectroscopy
with hermetic 14-Pin Butterfly Housing (RoHS compliant)	Metrology
including Monitor Diode, Thermoelectric Cooler and Thermistor	
with PM Fiber and angle-polished Connector (APC)	



### Absolute Maximum Ratings

Parameter	Symbol	Unit	min	typ	max
Storage Temperature	$T_S$	°C	-40		85
Operational Temperature at Case	$T_C$	°C	-40		85
Operational Temperature at Laser Chip	$T_{LD}$	°C	10		50
Forward Current	$I_F$	mA			130
Reverse Voltage	$V_R$	V			2
Output Power	$P_{opt}$	mW			12
TEC Current	$I_{TEC}$	A			1.8
TEC Voltage	$V_{TEC}$	V			3.2

### Measurement Conditions / Comments

Stress in excess of one of the Absolute Maximum Ratings may damage the laser. Please note that a damaging optical power level may occur although the maximum current is not reached. These are stress ratings only, and functional operation at these or any other conditions beyond those indicated under Recommended Operational Conditions is not implied.

### Recommended Operational Conditions

Parameter	Symbol	Unit	min	typ	max
Operational Temperature at Case	$T_{case}$	°C	-20		65
Operational Temperature at Laser Chip	$T_{LD}$	°C	15		35
Forward Current	$I_F$	mA			120
Output Power	$P_{opt}$	mW			10

### Measurement Conditions / Comments

measured by integrated thermistor

ex fiber

### Characteristics at $T_{LD} = 25^\circ\text{C}$ at BOL

Parameter	Symbol	Unit	min	typ	max
Center Wavelength	$\lambda_c$	nm	759	760	761
Linewidth (FWHM)	$\Delta\lambda$	MHz		2	
Mode-hop free Tuning Range	$\Delta\lambda_{tune}$	pm		1200	
Temperature Coefficient of Wavelength	$d\lambda / dT$	nm / K		0.06	
Current Coefficient of Wavelength	$d\lambda / dI$	nm / mA		0.003	
Sidemode Suppression Ratio	SMSR	dB	30	45	

### Measurement Conditions / Comments

see images on page 4

$P_{opt} = 10\text{ mW}$

see note 1)

$P_{opt} = 10\text{ mW}$

# SINGLE FREQUENCY LASER DIODES

## Distributed Feedback Laser



### Characteristics at $T_{LD} = 25^{\circ} \text{C}$ at BOL cont'd

Parameter	Symbol	Unit	min	typ	max
Mode-hop free Temperature Range	$T_{LD}$	$^{\circ} \text{C}$	15		35
Mode-hop free Power Range	$P_{opt}$	mW	2		10
Laser Current @ $P_{opt} = 10 \text{ mW}$	$I_{LD}$	mA			120
Slope Efficiency	$\eta$	W / A	0.1	0.2	0.4
Threshold Current	$I_{th}$	mA			70
Polarization Extinction Ratio	PER	dB		10	

### Measurement Conditions / Comments

SMSR > 30 dB, see note 1)

SMSR > 30 dB, see note 1)

$P_{opt} = 10 \text{ mW}$

1) This variant allows wavelength tuning by temperature or current variation; in case of external backreflections small mode-hops of 100 MHz or less may appear; the use of a BFW01 or TOC03 package variants and effective optical isolation is recommended for spectroscopic application requiring absolutely mode-hop-free tuning.

### Monitor Diode

Parameter	Symbol	Unit	min	typ	max
Monitor Detector Responsivity	$I_{mon} / P_{opt}$	$\mu\text{A/mW}$	5		200

### Measurement Conditions / Comments

$U_R = 5 \text{ V}$

### Thermoelectric Cooler

Parameter	Symbol	Unit	min	typ	max
Current	$I_{TEC}$	A		0.4	
Voltage	$U_{TEC}$	V		0.8	
Power Dissipation (total loss at case)	$P_{loss}$	W		0.5	
Temperature Difference	$\Delta T$	K			50

### Measurement Conditions / Comments

$P_{opt} = 10 \text{ mW}$ ,  $\Delta T = 20 \text{ K}$

$P_{opt} = 10 \text{ mW}$ ,  $\Delta T = 20 \text{ K}$

$P_{opt} = 10 \text{ mW}$ ,  $\Delta T = 20 \text{ K}$

$P_{opt} = 10 \text{ mW}$ ,  $\Delta T = |\text{Tcase} - \text{TLD}|$

### Thermistor (Standard NTC Type)

Parameter	Symbol	Unit	min	typ	max
Resistance	R	$\text{k}\Omega$		10	
Beta Coefficient	$\beta$			3892	
Steinhart & Hart Coefficient A	A			$1.1293 \times 10^{-3}$	
Steinhart & Hart Coefficient B	B			$2.3410 \times 10^{-4}$	
Steinhart & Hart Coefficient C	C			$8.7755 \times 10^{-8}$	

### Measurement Conditions / Comments

$T_{LD} = 25^{\circ} \text{C}$

$R_1 / R_2 = e^{\beta(1/T_1 - 1/T_2)}$  at  $T_{LD} = 0^{\circ} \dots 50^{\circ} \text{C}$

$1/T = A + B(\ln R) + C(\ln R)^3$

T: temperature in Kelvin

R: resistance at T in Ohm

# SINGLE FREQUENCY LASER DIODES

## Distributed Feedback Laser

### Pin Assignment

1	Thermoelectric Cooler (+)	14	Thermoelectric Cooler (-)
2	Thermistor	13	Case
3	Photodiode (Anode)	12	not connected
4	Photodiode (Cathode)	11	Laser Diode (Cathode)
5	Thermistor	10	Laser Diode (Anode)
6	not connected	9	not connected
7	not connected	8	not connected

Pins are isolated from case unless noted otherwise.

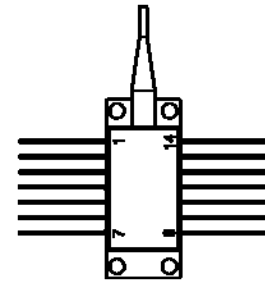

### Package Drawings

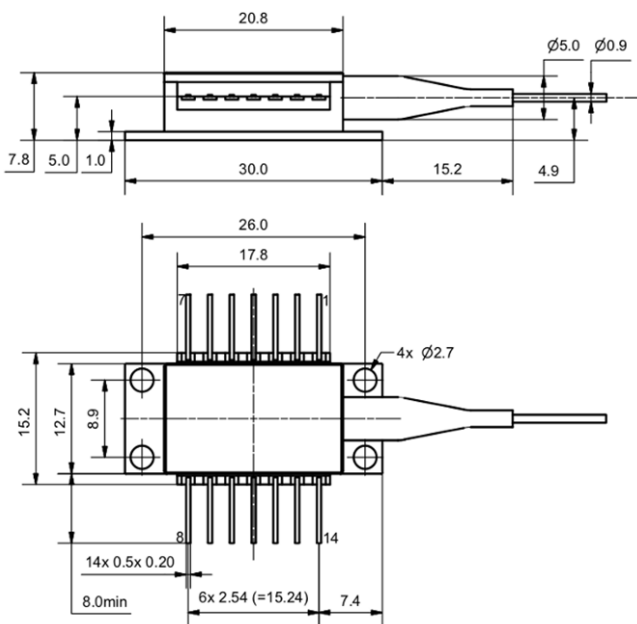

AIZ-16-0222-1415

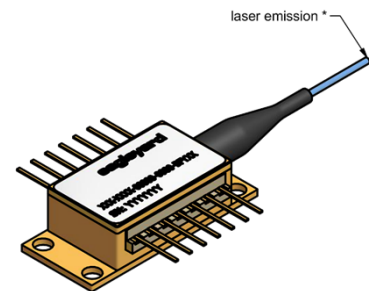

### Fiber and Connector Type

PM Fiber	900 / 125 / 5.5 $\mu\text{m}$ , UV/Polyester-elastomer Coating ( $l = 1 \pm 0.1 \text{ m}$ )
Connector	FC/APC (narrow key / 2mm)

### Measurement Conditions / Comments

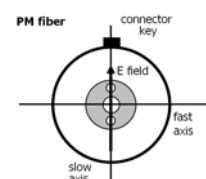

# SINGLE FREQUENCY LASER DIODES

## Distributed Feedback Laser

### Typical Measurement Results

Output Power vs. Current

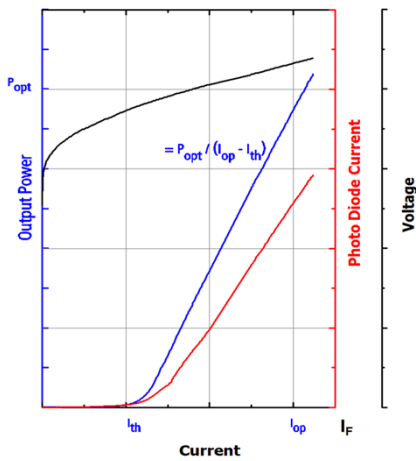

Spectra at Specified Optical Output Power

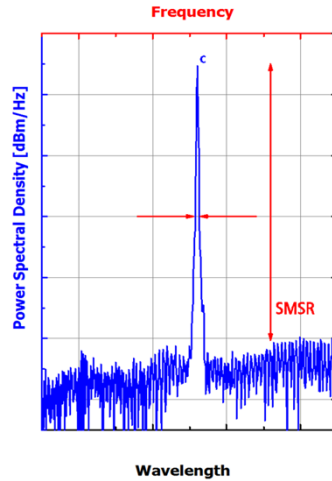

### Unpacking, Installation and Laser Safety

Unpacking the laser diodes should only be done at electrostatic safe workstations (EPA). Though protection against electro static discharge (ESD) is implemented in the laser package, charges may occur at surfaces. Please store this product in its original package at a dry, clean place until final use. During device installation, ESD protection has to be maintained.

The DFB laser is sensitive against optical feedback, so an optical isolator may be required in order to avoid any disturbance of the emission spectrum. Operating at moderate temperatures on proper heat sinks will contribute to a long lifetime of the diode.

Avoid direct and/or indirect exposure to the free running beam. Collimating and focussing the free running beam with optics as common in optical instruments will increase threat to the human eye.

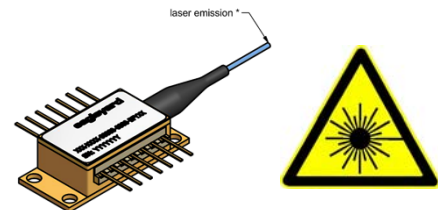

IEC-60825-0



Complies with 21 CFR 1040.10 and 1040.40